

BRAVO SNORKEL



MERCEDES SPRINTER

VARIANT: W910 (2021 - On.)

ENGINE: 2.1 / 3.0

REF: SMSV

FITMENT SIDE: Left

LINEAR LOW DENSITY POLYETHYLENE RESINE



LL 8446 is a linear low density butene copolymer designed to offer excellent processability, whiteness, and fast grinding rate. This UV stabilized resin is ideally suited for applications that require excellent dimensional control and low warpage.

PROPERTIES

Additive

Long Term UV-8 Stabilizer

Density

0.936 g/cm³ (Based on ISO 1183)

Melt Index (190°/2.16 Kg)

5.0 g/10min (Based on ISO 1183)

PART	DESCRIPTION	QTY
1	Snorkel body	x1
2	Snorkel head 89 mm / 3,5"	x1
3	Black clamp	x1
4	Bracket	x1
5	Rivet 4,8 x 12 mm	x3
6	Allen bolt M6 x 12 mm	x2
7	Rubber washer M5 x 14 mm	x3
8	Fender template	x1
9	Inner template	x1
10	Allen bolt M6 x 30 mm	x2
11	Washer M6 x 20 mm	x2
12	Rivnut M6 x 14 mm	x2

PART	DESCRIPTION	QTY
13	Rubber duct connecting	x1
14	Clamp 90 - 110 mm	x2
15	Clamp 80 - 100 mm	x3
16	Metal ring 89 mm ED	x2
17	Flex hose 89 mm / 300 - 950 mm	x1
18	Rubber duct connecting	x1
19	Metal U bracket	x1
20	Metal U bracket	x1
21	Filter template	x1
22	Filter template	x1
23	Waterproof rivet 4 x 12,5 mm	x16
24	Filter plate	x1

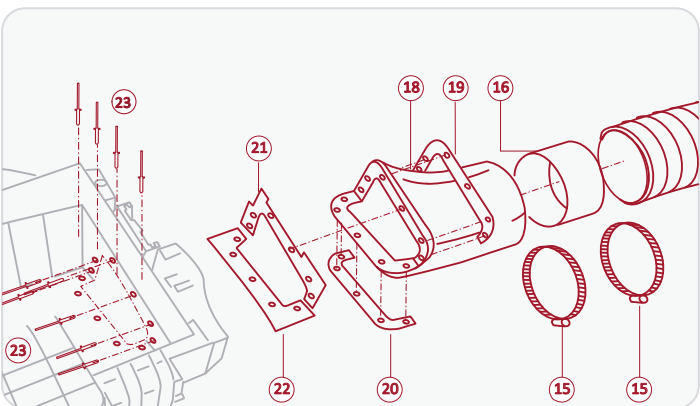
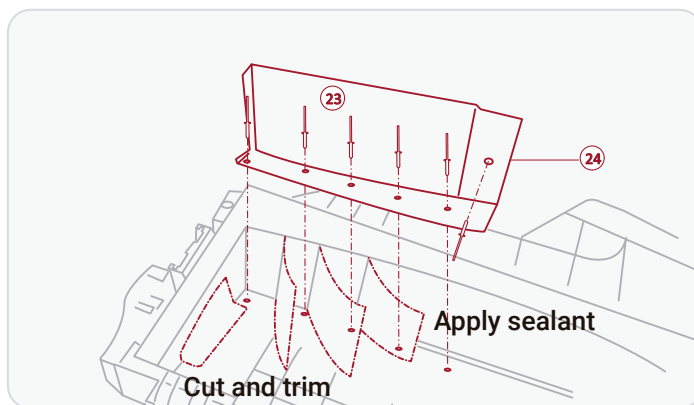
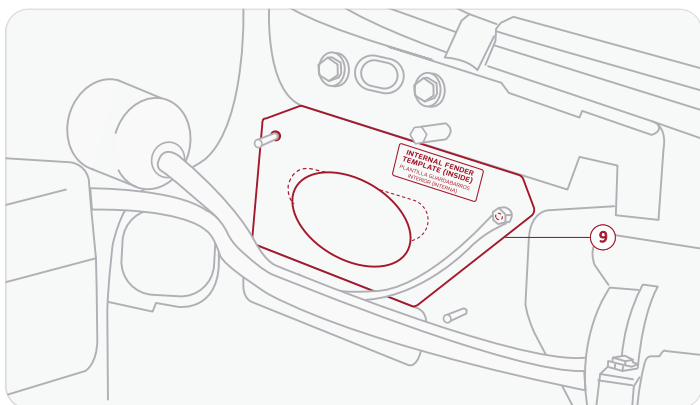
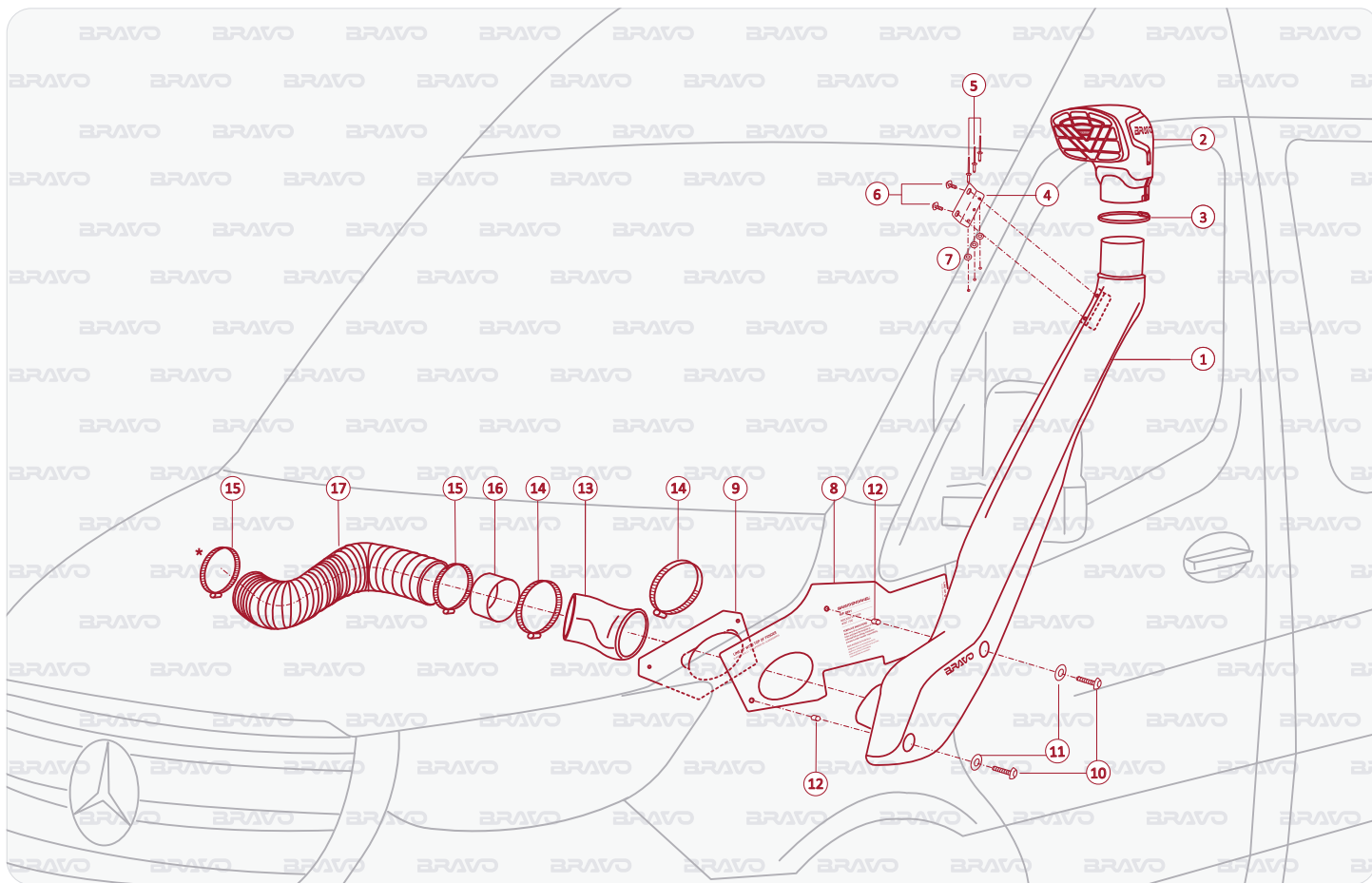

Installation process is under installer's responsibility.